

NSU

Quickly

INSTRUCTION BOOK

Quickly-**N**ormal

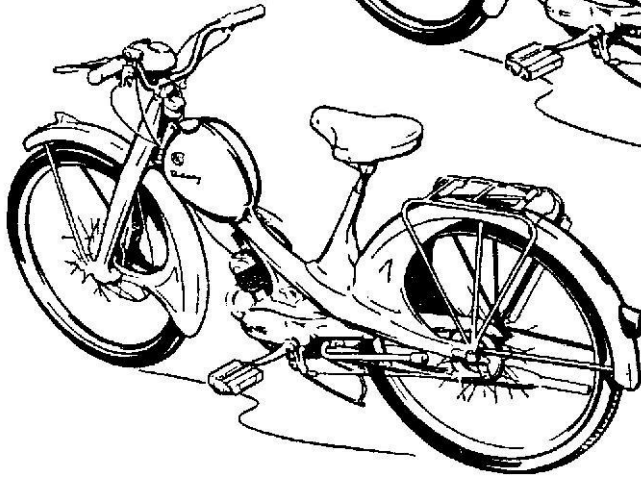
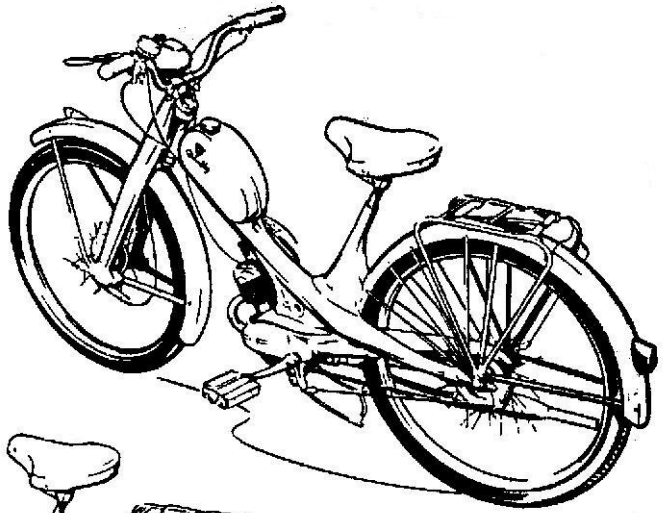

Quickly-**S**pecial

Quickly-**L**uxe

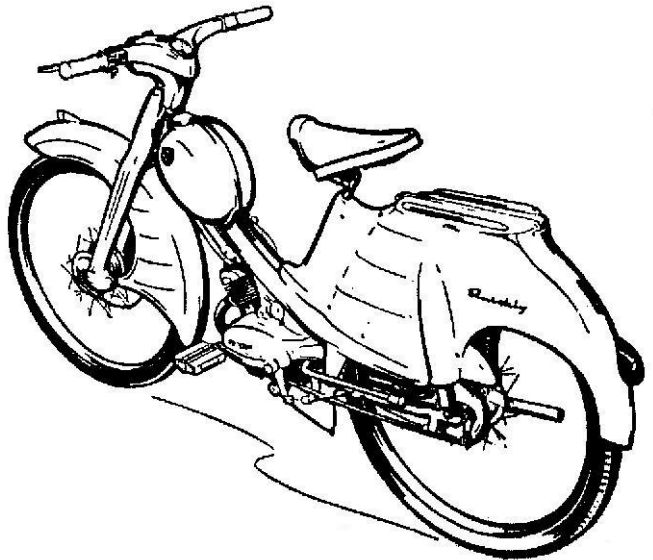

Dear NSU Friend,

We would ask you to study this instruction book carefully, and thus acquaint yourself not only with all the interesting details of your new machine, but especially with all the hints and advices we offer you for the correct servicing of your machine.

Furthermore, we would ask you, according to the directions given in the attached **Service and Inspection Card**, to take your machine to an NSU Dealer's workshop in order to have the various jobs, suggested by the works, carried out by experts. Only NSU Dealers have, besides **original NSU spares**, time-saving special tools and maintenance manuals at their disposal, as well as expert mechanics specially NSU-trained. We would therefore suggest that you take your machine, in case of repair work, too, always to your **NSU-Dealer**.

Any guarantee claims that might arise are to be reported to your Dealer for his examination, who then has to bring the case to the General Agent's attention. All guarantee claims submitted direct to the General Agent can only be finalized on having the Dealer's report.

Repair jobs at the General Agent's can only be carried through on appointment made beforehand through your Dealer.

Finally, we would ask you to always adhere to our well-meant advice, and wish you

Many Miles of Trouble-free Riding on NSU!

NSU WERKE AKTIENGESELLSCHAFT NECKARSULM

Description	
Engine	8
Engine Lubrication	8
Carburettor	9
Electrical Equipment	9
Power Transmission Engine — Gearbox	9
Clutch	9
Change-speed Gear	9
Pedals	9
Power Transmission Gearbox — Back wheel	10
Frame	11
Front Forks	11
Rear Wheel swinging Arm	12
Steering Head	12
Handlebars	12/13
Saddle	13
Fuel Tank	14
Road Wheels	14
Brakes	14
Stand	14
Carrying Handle	14
Tool Box	15
Pump	15
Lock	15

Riding Instructions

Running-in speeds	16
Tyre Pressure	16
Petrol Mixture	17
Fuel Tank Capacity	17
Fuel Cock	17
Starting the Engine	18
Riding	19
Changing Gear	19
Engaging neutral when brought to a stop in traffic, etc.	19
Changing down	20
Braking	20
Peddalling	21
Stopping Engine	21

Care of the Machine

Cleaning	22
Periodic Lubrication	22
Engine Lubrication	23
Front Forks Swinging Links	23
Rear Wheel Swinging Arm	23
Bowden Cable of Rear Brake	24
Gearbox Oil Level	24
Driving Chain	25
Brake Rod	25
Air Filter	26
Changing Gearbox Oil	27
Bowden Cables	27
Drawing of Engine	30/31
Levers and Joints	28
Speedometer	28
Lubricating Pad	28
Pedal Bearings	29
Interior of Throttle and Gear Change Twist Grips	29
Front and Rear Wheel Bearings	29
Steering Head Bearings	29

Maintenance of the cycle parts:

Front Wheel	32
Back Wheel	32/33
Chain Tension	34/35
Removing and Fitting Front Wheel	36/37
Removing and Fitting Back Wheel	38/39
Fitting Tyres	40

of the engine:

Dekompression cable	41
Clutch	41
Gear Change Mechanism	42
Carburettor	42/43
Electrical Equipment	43-46
Adjustment of Contact Breaker Points	44
Sparking Plug	45
Ignition Timing	45
Head Lamp	46
Head Lamp Adjustment	46
Engine Overhauls	47
Routine Inspection	48
Lubrication Chart	49
Routine Lubrication and Inspection	50/51
Flat Rate Repair Times	52/58
Fault Tracing	59
Wiring diagram	60

TECHNICAL

ENGINE

Engine	NSU QUICKLY, unit construction
Cylinder	Light-alloy with hardchromed bore
Bore	40 mm
Stroke	39 mm
Capacity	49 cc
Compression ratio	1 : 5.5
Output	1.3 h. p.
Speed	5000 r. p. m.
Cycle	Two-stroke
Valve timing	Ports
Lubrication	Petroil mixture
Mixture	1 Imp. Gall. Fuel: $\frac{1}{3}$ Pint Oil (SAE 50)
Ignition	Flywheel Magdyno
Carburettor	Bing single slide carburettor
Air cleaner	Wet-air filter (in frame) with choke flap
Clutch	Multi-disc clutch
Clutch operation	by hand
Gearbox	NSU 2-speed unit gearbox
Power transmission	Chain

DATA

FRAME

Frame	Pressed steel (Box type)
Front forks	Sprung swinging link
Rear forks	Rear wheel swinging arm
Fuel tank capacity	4.45 litres
Stand	Spring stand (centre stand) Quickly-N Spring stand and side stand Quickly-S and L
Rims	Well-base, 26x2
Tyres	Low pressure 26—2
Permissible load	1 Person
Foot-rests	Pedals
Front brake	Internal expanding brake
Rear brake	Internal expanding brake
Brake operation	Front: Hand. Rear: Foot. Quickly-N and S Quickly-L
Maximum Height	960 mm, adjustable 990 mm
Maximum Width	642 mm 670 mm
Maximum Length	1895 mm 1900 mm

EQUIPMENT

Electrical equipment	Flywheel magdyno, Head lamp, Rear lamp, and Rattle
Accessories	Tools, Luggage carrier, Lock, and Pump
Provided at extra charge if required	Speedometer

Alterations may be made in the design or the equipment.

DESCRIPTION

Engine *

The engine is an air-cooled NSU two-stroke engine.

It is fitted with a light alloy cylinder the bore of which is hard-chromed, thus providing a surface resistant to both wear and corrosion. The piston is of light alloy, and controls the loop scavenging process by covering and uncovering the exhaust and transfer ports.

The compression release valve fitted in the light alloy cylinder head assists in starting and stopping the engine; it is operated through a Bowden cable by means of a lever on the left-hand handlebar.

Roller bearings are fitted throughout.

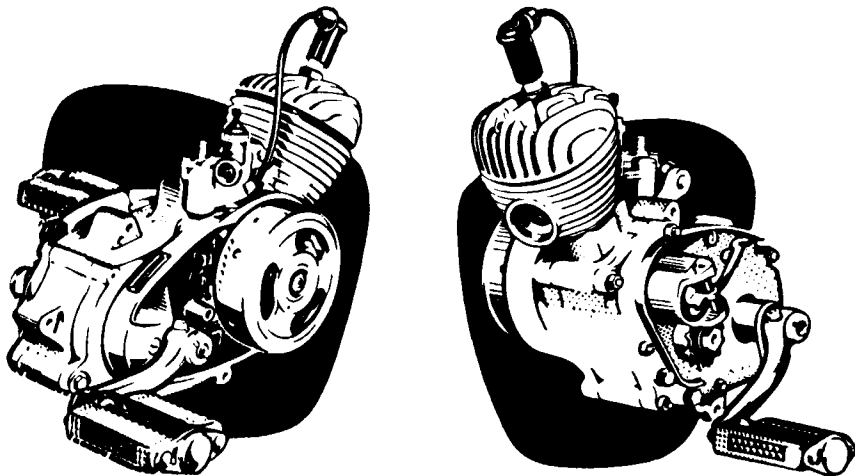

Engine Lubrication

By means of engine oil ** mixed with the fuel.

Petrol ratio: 1 Imp. Gall. Fuel: $\frac{1}{3}$ Pint Oil (SAE 50)

* see pages 30 and 31

** see page 49

Carburettor

Single-slide type; operated by twist-grip on handlebars through an adjustable Bowden cable. **Wet-air filter** with choke flap on frame. The choke flap is opened and closed by means of the rotating disc at the bottom of the frame — its position is marked.

Electrical Equipment

The flywheel magdyno, on the right-hand end of the crankshaft, provides the electrical current for the sparking plug, for the rattle, the head lamp, and the rear lamp.

Power Transmission Engine — Gearbox

By means of gear wheels running in an oil bath.

Clutch

Multi-plate clutch with 2 outer and 1 inner disc. Operated by means of a lever on the left-hand handlebar through an adjustable Bowden cable.

Change-speed Gear

2-speed, built in unit with the engine. Constant-mesh gears, operated by fork and sliding dogs. Gear change by means of twist grip fitted with gear indicator on the left-hand handlebar, and operating through an adjustable Bowden cable.

The Pedals

are attached to the gearbox and are used for the following purposes:

1. For starting the engine, in which case the compression release valve should be opened.
2. To assist the engine on steep hills.
3. For pedalling when the engine is not working. In this case engage second gear, and lock the clutch in the disengaged position.
4. For braking by back-pedalling.

Power Transmission Gearbox — Back Wheel.

A single chain is fitted. The roller chain is provided with a dirt-proof casing.

Chain adjusters are fitted at the ends of the forks.

Quickly-N and S

Chain adjusters are fitted at the ends of the rear wheel swinging arm. **Quickly-L**

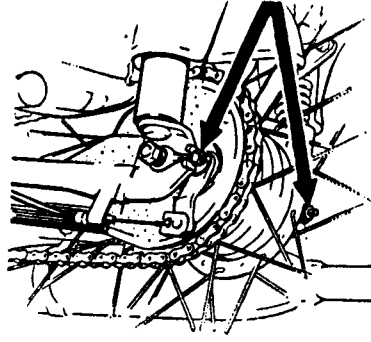
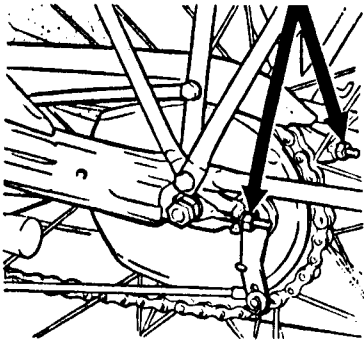

Frame

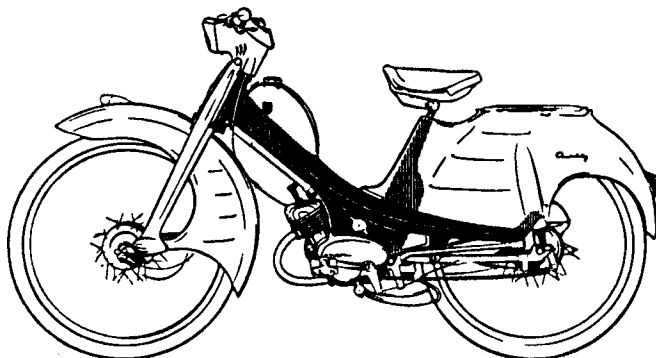

Frame

The frame is of pressed steel, and is in the form of a box girder.

The Front Forks

are pressed out of sheet steel. The **swinging links** on the ends of the forks have clamps at their front ends to hold the axle and a compression spring holds each of them away from the fork ends.

Quickly-N and S

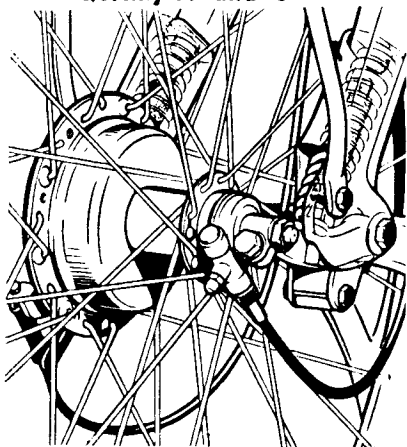

Quickly-L

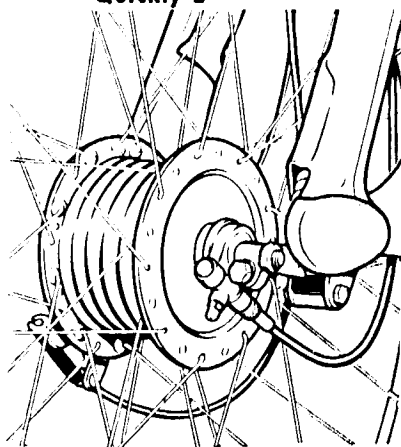

The Rear Wheel Swinging Arm Quickly-L

bears against the frame, on either side of it, through compression springs.

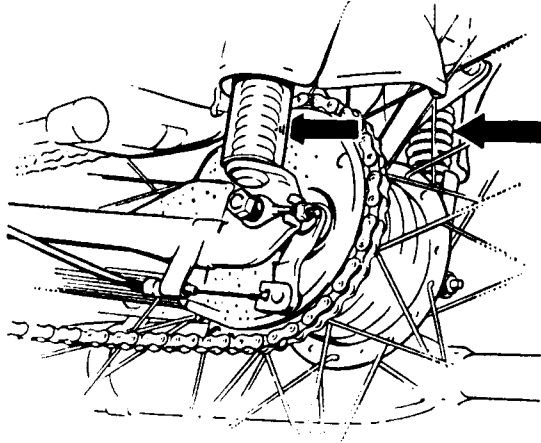

Steering Head

The steering head is fitted with an adjustable ball bearing.

Handlebars

Quickly-N and S: The handlebars are held in clips and can be adjusted.

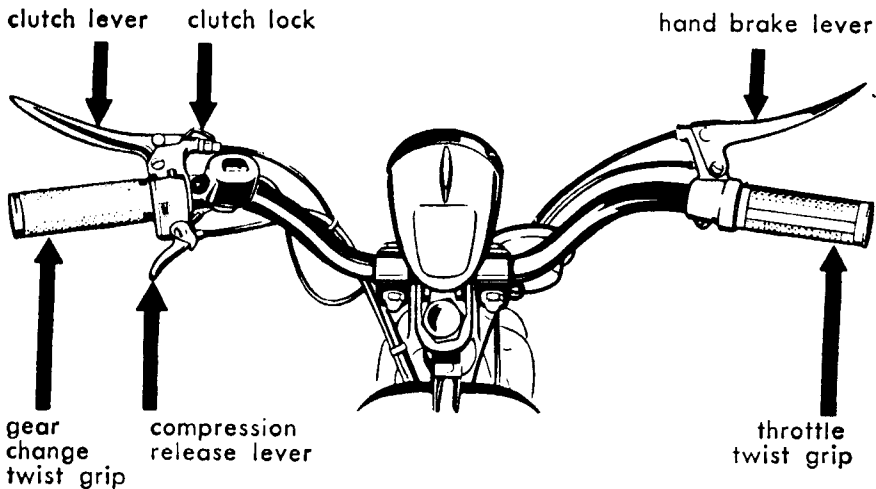

Quickly-L: The handlebars differ from the conventional tubular handlebars in that they are U-cross-section, open at the bottom. As a result all the control cables can be located out of sight.

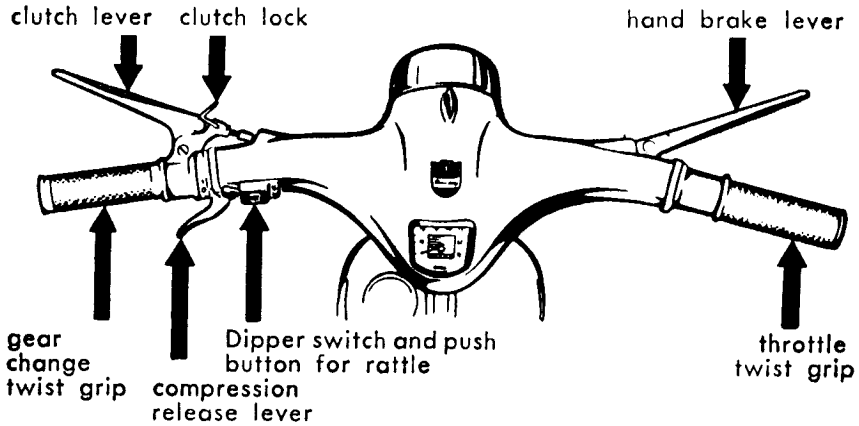

Saddle

is adjustable to give a comfortable riding position.

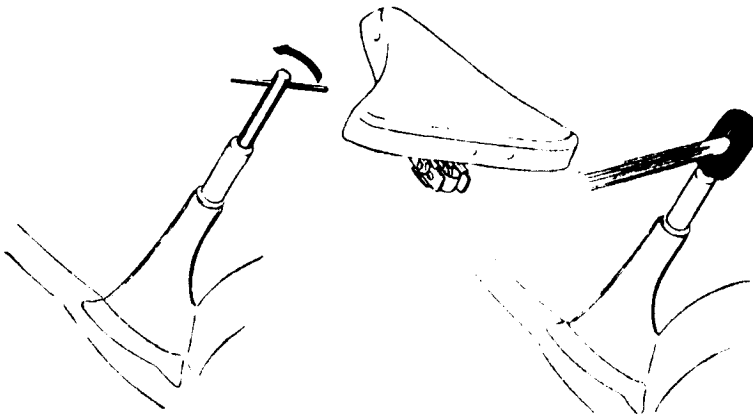

If the saddle is to be raised or lowered, remove the saddle, and loosen the clamping bolt a couple of turns. If the clamping nut is caught, free it by hammering the head of the clamping bolt. The saddle tube can now be

set to the required height, and is held in position by tightening up the clamping bolt. Refit the saddle.

Do not raise the saddle higher than the mark "o".

Fuel Tank

is mounted on rubber and attached to the frame by means of a metal strap.

Road Wheels

have deep well-base 26x2 rims, and are fitted with 26—2" wired-on low-pressure tyres, adjustable ball bearings, and pin axles.

Brakes

Front: Internal expanding brake, operated by hand lever fitted on the righthand handlebar operating through a Bowden cable.

Rear: **Quickly-N and S:** Internal expanding brake, operated by, back pedalling, and actuated by means of a brake rod.

Quickly-L: Internal expanding brake, operated by, back pedalling, and actuated by means of a Bowden cable.

Stand: **Quickly-N:** Spring stand (central stand).

Quickly-S and L: Spring stand and side stand.

A Carrying Handle fitted to the right-hand side of the engine and frame makes it easy to carry the QUICKLY up and down steps.

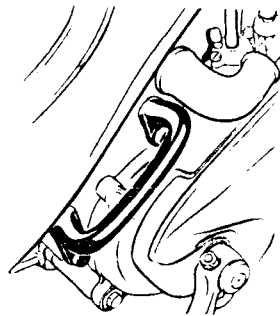

The Tool Box

is incorporated in the front forks under the head lamp.

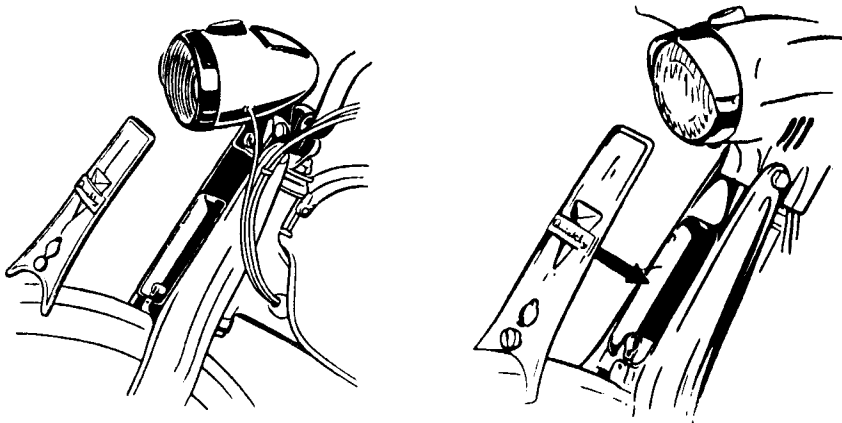

The pump

Quickly-N and S: The pump is carried on the right-hand side of the luggage carrier.

Quickly-L: The pump is carried in front of the handlebars, at the left.

The Safety Lock

is attached to the front forks (tool box).

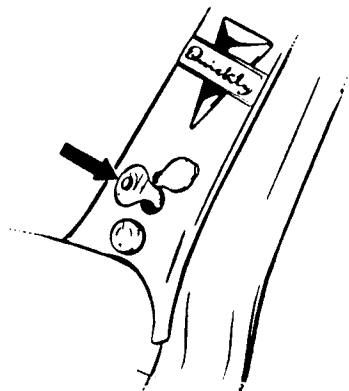

RIDING INSTRUCTIONS

The design of the QUICKLY is so simple that very little thought and skill is necessary to ride it. The following paragraphs give the necessary instructions. They should be read before using the machine for the first time; don't worry — we shall be as brief as possible.

For the first 200 miles avoid running with the throttle fully open; from 200 to 400 miles it is possible gradually to increase the load on the engine until the full power is used in both gears. During this running-in period run the engine at various loads; do not keep it turning at the same speed. Also don't allow the engine to slog when running up-hill, but change down into bottom gear.

After the first 300 and 600 miles change the oil in the gearbox; instructions for this are given on p. 27.

All the engine-mounting bolts should be checked by this opportunity and re-tightened where necessary. See also "Routine inspection", page 48.

All grease and oil points, such as the wheel hubs, the gearbox* on a new QUICKLY are filled with oil or grease. They will, therefore, not require any attention to begin with.

For saddle adjustment see page 13.

Before every trip check the tyre pressure.

That is to say that it should be just possible to press the tyre in with the thumb; **front 2 atm, rear 2,2 atm.** The tyre pressures will of course vary according to the load of the machine.

* When taking delivery check the oil level; details of this are given on p. 24.

Important

Always fill up with a two-stroke mixture

If there is no oil added to the fuel, the piston will seize up and will become scored; it is then useless.

Use only a proprietary engine oil * and a proprietary petrol

Mixture ratio

1 Imp. Gall. Fuel : $\frac{1}{3}$ Pint Oil (SAE)

That is to say there should be 40 cc of oil to every litre of petrol, or 1 quart of oil to 25 quarts of petrol. The petrol and oil must be well mixed before it is poured into the tank.

The fuel tank holds 4.45 litres

If the QUICKLY is unused for some hours or left standing overnight, the mixture in the tank should be well shaken up before the fuel tap is opened.

To open the fuel Cock **

Handle upright = open; a reserve supply amounting to 0.5 litres will remain in the tank.

Handle horizontal to the left (R) = all the fuel will be used.

Handle horizontal to the right (Z) = fuel cock closed.

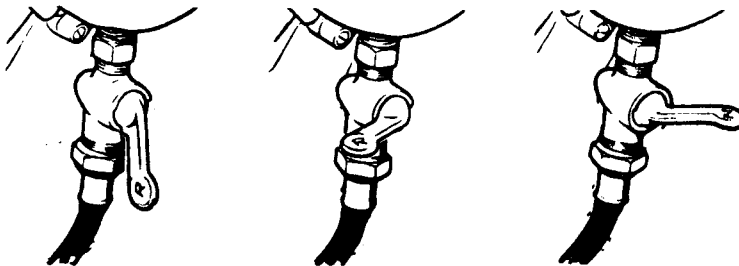

* see Lubrication Chart, p. 49

**Handle positions depend on make of fuel tap fitted.

Gently depress the tickler on the carburettor to check whether the float chamber is filling with petrol. Do not let the carburettor overflow. Only in cold weather when the engine is cold may the fuel be allowed to overflow briefly in order to ensure that a sufficiently rich mixture is available. In cold weather the choke flap on the carburettor air intake should also be closed.

Starting the Engine

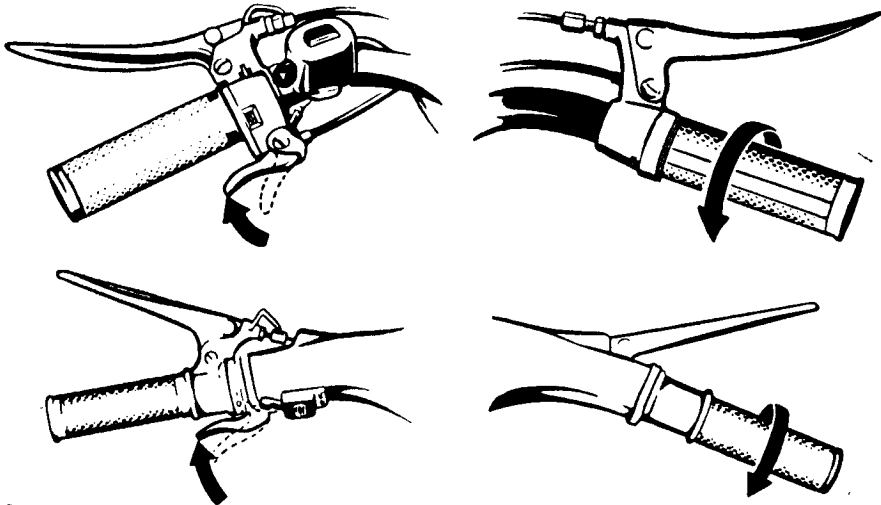

Lower the machine from its spring stand and lift side stand.

Set the gear change twist grip to neutral (0), pulling the clutch lever right home while you do so. Open the throttle twist grip 1/4 to 1/3.

The choke flap on the carburettor air intake should be closed only in cold weather. Raise the compression release lever and swing the left-hand pedal, which should

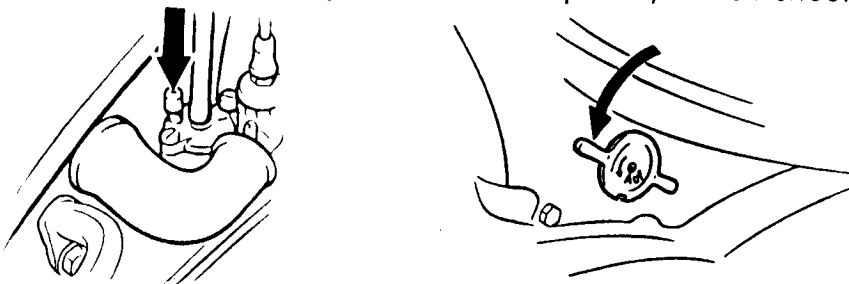

have been raised, down with the foot like a kickstarter; during the last third of this swing release the compression release lever. If the engine does not fire the first time, dis-engage the clutch and return the pedal to the starting position. When the engine is running close the throttle and open the choke flap if this was closed; if this causes the engine to stall, partially close the flap again until the engine runs properly.

Riding

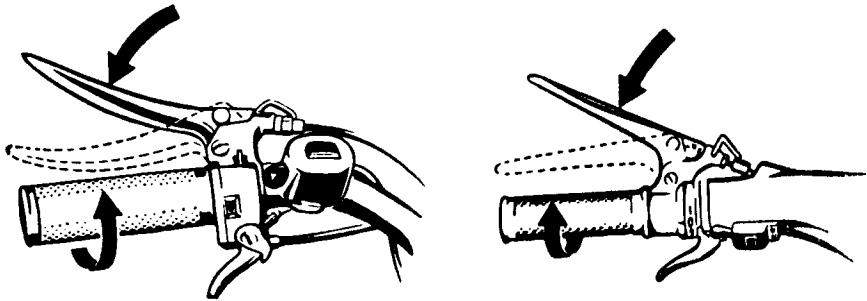

Disengage the clutch (pull the lever in as far as it will go), and engage 1st. gear — do not let go of the clutch lever yet — and mount the QUICKLY in the same way as a bicycle. The clutch can then be let in gently — not suddenly — at the same time opening the throttle, and, if necessary, pedalling. Change up into 2nd gear before the engine starts to race in 1st gear. Since the QUICKLY is now moving the clutch can be let in more rapidly.

The speed should be controlled only by means of the throttle, and never by raising the compression release lever (this causes piston damage). The compression release lever is fitted only for assistance in starting and for stopping the engine.

Take care not to back-pedal while running — this causes heavy wear on the brakes and an increased fuel consumption.

When stopping at level crossings or because of traffic hold-ups, don't keep the engine running in gear with the clutch out, but change into neutral and close the throttle. The engine will then tick over. When the road is clear start off again as described above.

Never forget to pull the clutch lever as near to the twist-grip as it will go before changing gear. Failure to do this will prevent the clutch from disengaging properly, and will cause damage to the gearbox and chain.

Don't keep the engine running at full throttle, even when it is properly run-in, but ease down to 3/4 throttle. This also applies when you have accelerated and want to keep up a given speed; if the throttle is eased back until this speed is just maintained, the fuel consumption will be a minimum.

When climbing hills, or if it is desired to proceed slowly in traffic, it is necessary to change down in good time. To do this, first **pull in the clutch lever**, close the twist-grip to give about 1/2 throttle, and turn the gear change twist-grip to engage 1st gear; then release the clutch, and, if necessary, open the throttle. This changing-down process must be performed quickly in order not to lose too much speed. The engine must never be allowed to slow down so much that it labours, but must always run evenly. If a short hill is to be surmounted without changing down, it is definitely wrong to let the clutch slip — this will damage the clutch — instead, assist the engine by pedalling.

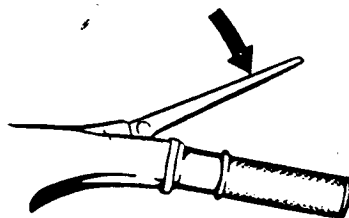
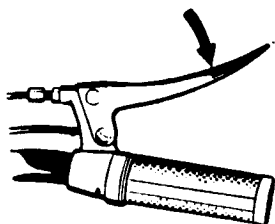

When braking close the throttle, and back-pedal as on a bicycle. Do not use the rear brake only, excepting on wet, slippery curves (damp leaves). The best braking effect is achieved if the front and rear brakes are applied together slowly but firmly. When descending a long hill rev the engine up now and again: this prevents the engine from running without oil. Depending on the steepness of the hill either use the brakes simultaneously, or the front and rear brakes alternately.

Locking catch

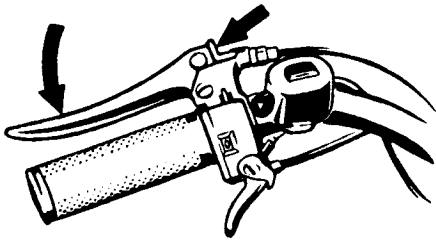

Locking catch

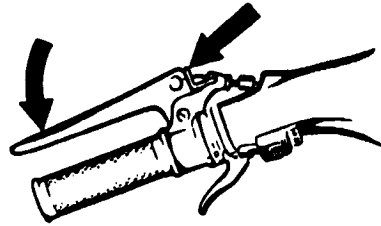

In an emergency, for instance if you have run out of petrol, the QUICKLY can be pedalled like a bicycle. The 2nd gear should then be engaged, and the clutch locked in the disengaged position. To do this pull the clutch lever in to the handlebars, engage the locking catch, and then release the clutch lever.

The locking catch should be released at the earliest opportunity!

At the end of the journey close throttle twist grip, let out the clutch and engage neutral. Let the QUICKLY run to a standstill, applying the brakes as necessary. Finally stop the engine by pulling up the compression release lever. **Do not come to a standstill with the engine in gear, "killing it off" with the aid of the brakes.**

Close the fuel tap as soon as the machine is stationary.

Fuel can be saved by turning the tap off some 200-300 yards before reaching the destination. If this is done the engine will also be much easier to start, since no oil deposits can then settle on the carburettor jet.

CARE OF THE MACHINE

If you look after your QUICKLY properly, that is to say handle it correctly, clean it regularly, and follow the lubrication instructions you will be able to rely on your machine being always ready for use.

Cleaning

Clean the outside of the engine with paraffin or cleaning petrol. The enamelled parts should be cleaned with water using a leather or a sponge. Dried mud should first be softened, and large lumps of dirt cleaned out of the corners with a piece of wood, followed by a wash down.

Take care when hosing down!

The water jet should never be played directly on the hubs or the carburettor; the bearings will rust, while water in the carburettor and fuel tank will make the engine difficult to start, or stop it when it is running. The carburettor should therefore be covered up and the choke flap closed. Very greasy parts should be cleaned with paraffin or a washing solvent, and not with petrol since this will damage the enamel. Any petrol spilled while filling up should also at once be wiped clear.

Periodic Lubrication

Grease points and nipples should be cleaned before greasing commences.

During bad weather the grease points on the frame and the control linkages (front fork swinging links, brake rod, **Quickly-L**: rear wheel swinging arm, . . .) should be lubricated more often than stated; if any squeaks develop, grease **at once**.

The **driving chain** must never be allowed to run dry. This should, therefore, be oiled frequently, particular attention being paid to the rollers.

Engine Lubrication

is, of course, effected by means of engine oil * which should be well mixed with the petrol before it is poured in the tank. We have already dealt with this point.

Remember the mixture ratio:

1 Imp. Gall. Fuel : $\frac{1}{3}$ Pint Oil (SAE 50)

Approximately every 300 miles

Front Fork Swinging Links

Force one or two strokes of grease * into the grease nipples on the swinging link bearings on the front forks. At the same time oil the rollers of the chain.

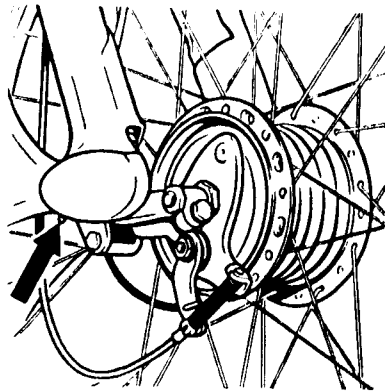
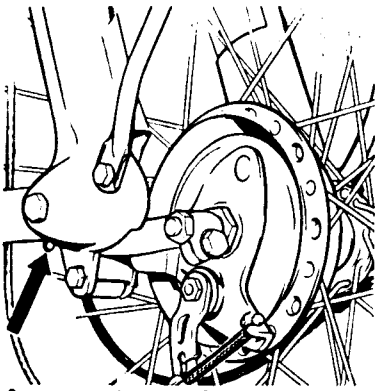

Approximately every 300 miles

Force grease * into the nipples on either side of the rear wheel swinging arm of **Quickly-L** until it comes out of the bearing.

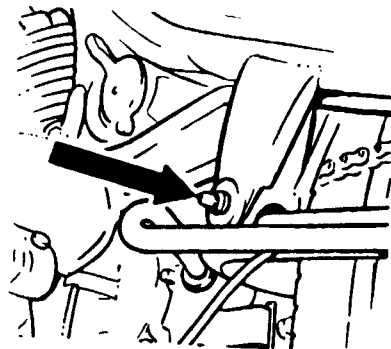
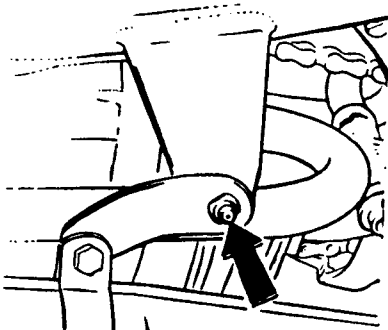

* see Lubrication Chart, page 49

Approximately every 300 miles

Bowden cable of rear brake Quickly-L

Press grease through the nipple until it comes out at either end of the Bowden cable.

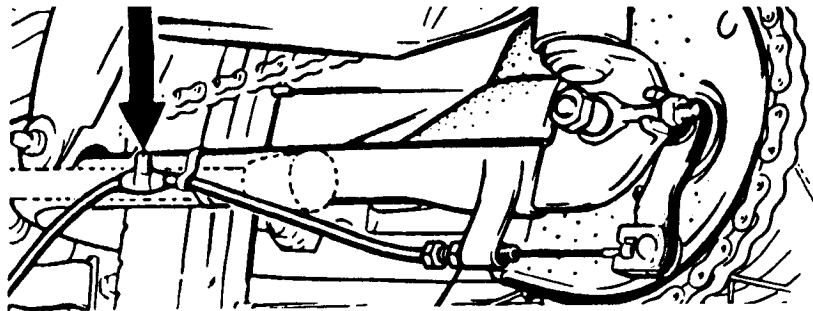

Approximately every 600 miles

The Gearbox Oil Level

should be checked after removing the filler plug and the oil check plug, and oil * added to bring the level up to that of the check plug orifice.

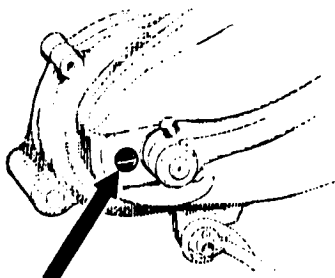

filler plug

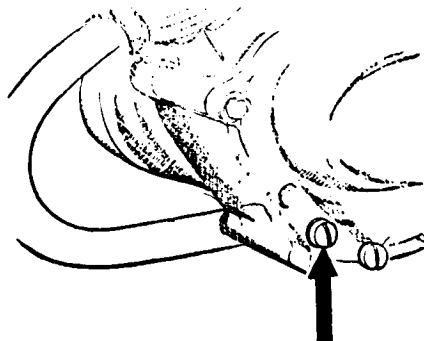

check plug

* see Lubrication Chart, page 49

Approximately every 600 miles

The Driving Chain

as we mentioned before, must never be allowed to run dry; the oil can should therefore be frequently used on the chain — and in particular the rollers. The chain should also be periodically greased in the following manner:

Remove the spring link, and push out the connecting link. Take the chain off, and brush it with paraffin or petrol, treating each link separately, until all the dirt has been removed. Then swill the chain once more in paraffin or petrol, lay it in a tin containing warmed chain grease, and move it to and fro. Take out while still somewhat warm and let surplus grease drip off. The spring link by means of which the chain is secured should be attached so that its closed end points in the direction of motion of the chain.

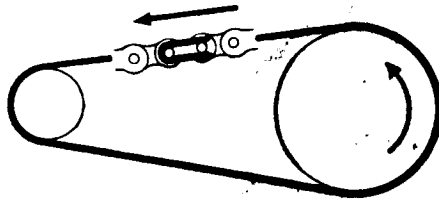

Approximately every 600 miles

Grease with high-pressure grease both connections and bearings of the brake rod and of the spring stand (centre stand) and side stand, respectively.

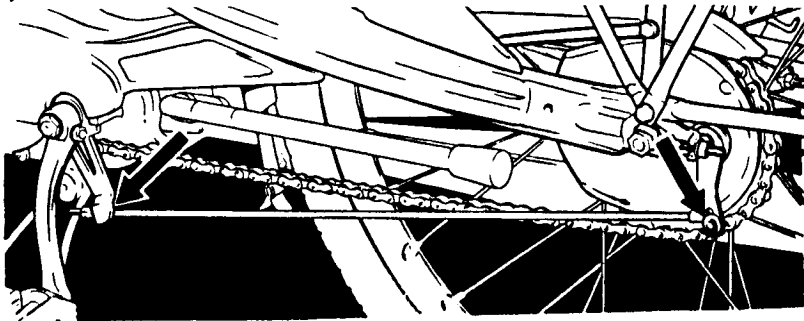

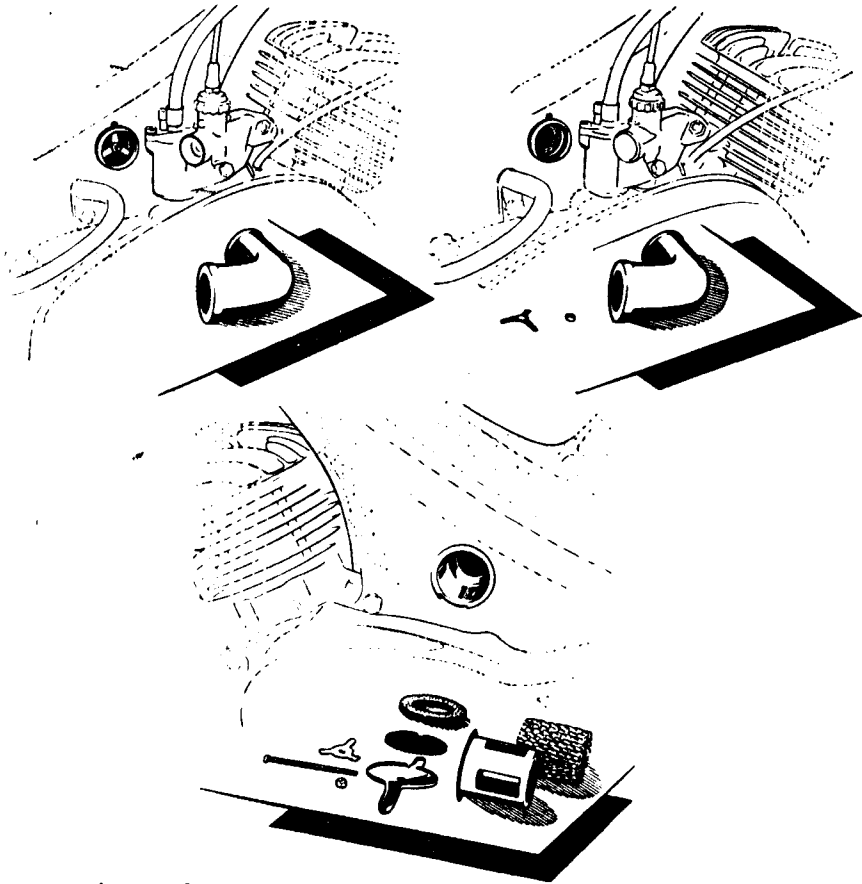

Approximately every 1 200 miles

Air Filter

A dirty air filter can cause the fuel consumption to increase quite considerably. The filter pad should therefore be thoroughly washed out in petrol, blown through with compressed air, and dipped in thin oil; the surplus oil should be allowed to drip off before the filter is replaced. If necessary the filter should be cleaned earlier.

To dismantle the air filter, the rubber union between the filter and the carburettor should be removed. The bolt holding the air filter in place is then unscrewed, the cover plate on the right hand side (choke flap) removed, and the filter can then be withdrawn.

Approximately every 1 200 miles

The Gearbox oil must be changed

only while the engine is warm. The filler plug on the right-hand side of the engine, together with the oil level check plug and the drain plug on the left-hand side of the engine, must be removed. The used oil will then drain off, after which the drain plug should be replaced, and the gearbox filled with flushing oil to the level of the check plug orifice. Replace the filler and oil level plugs, and run the engine for a short time. The flushing oil must then be completely drained off, and fresh oil * poured in to the level of the check plug orifice after the drain plug has been replaced. Finally replace the filler plug and the oil level check plug.

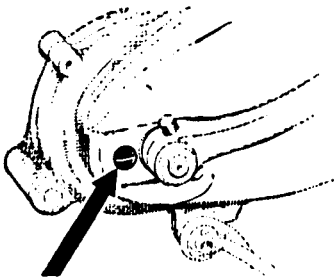

Filler plug

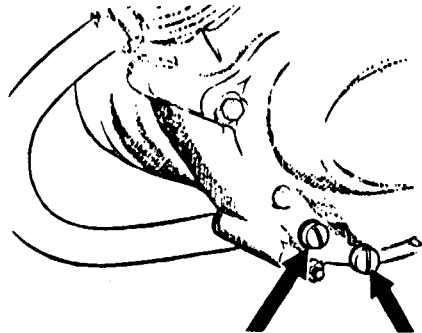

check plug Drain plug

Approximately every 1 200 miles

Bowden Cables

After disconnecting the cables drip oil into the upper end of the outer casings until it appears at the lower end. The cable should also be greased where it enters and leaves the casing to prevent water penetrating. Particular attention should be paid to the clutch cable in this connection (remove the left-hand engine cover plate). Bowden* cable lubricators can be obtained from accessories shops, and it will be found that these simplify this task considerably.

* see Lubrication Chart, page 49

Approximately every 1 200 miles

Levers and Joints

such as the hand levers on the handlebars for actuating the compression release valve, the clutch, the front brake, and the saddle bearing should be treated with a few drops of the oil* used in the gearbox.

Approximately every 1 200 miles

Speedometer

Apply grease* to the **speedometer drive**.

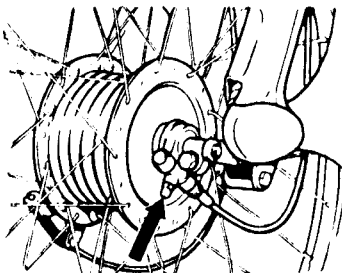

Approximately every 1 200 miles

Lubricating Pad**

Apply a 1 mm thick layer of bearing grease (drip point 150-160° C) and rub well into the pad.

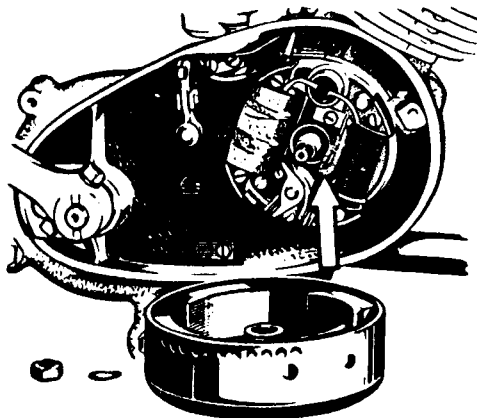

* see Lubrication Chart, page 49

** It is advisable to have the lubrication works carried out in the repair shop of an NSU Agency.

Approximately every 2 400 miles

The Pedal Bearings

should be given a few drops of oil * , the QUICKLY being leaned over, and the pedals turned.

Approximately every 4 800 miles

**The Interior of the Throttle and Gear Change
Twist Grips ****

should be greased with high-pressure grease.*

Approximately every 4 800 miles

Front and Rear Wheel Bearings **

Remove bearing cone and seal from the previously dismantled wheel; pack the ball bearings with fresh grease, removing first all traces of old grease.

Steering Head Bearings ** — In case of overhauling
After cleaning the bearings, bed the balls in grease.*
For adjustment of the steering head bearings. s. page 48

* see Lubrication Chart, page 49

** It is advisable to have the lubrication works carried out in the repair shop of an NSU Agency.

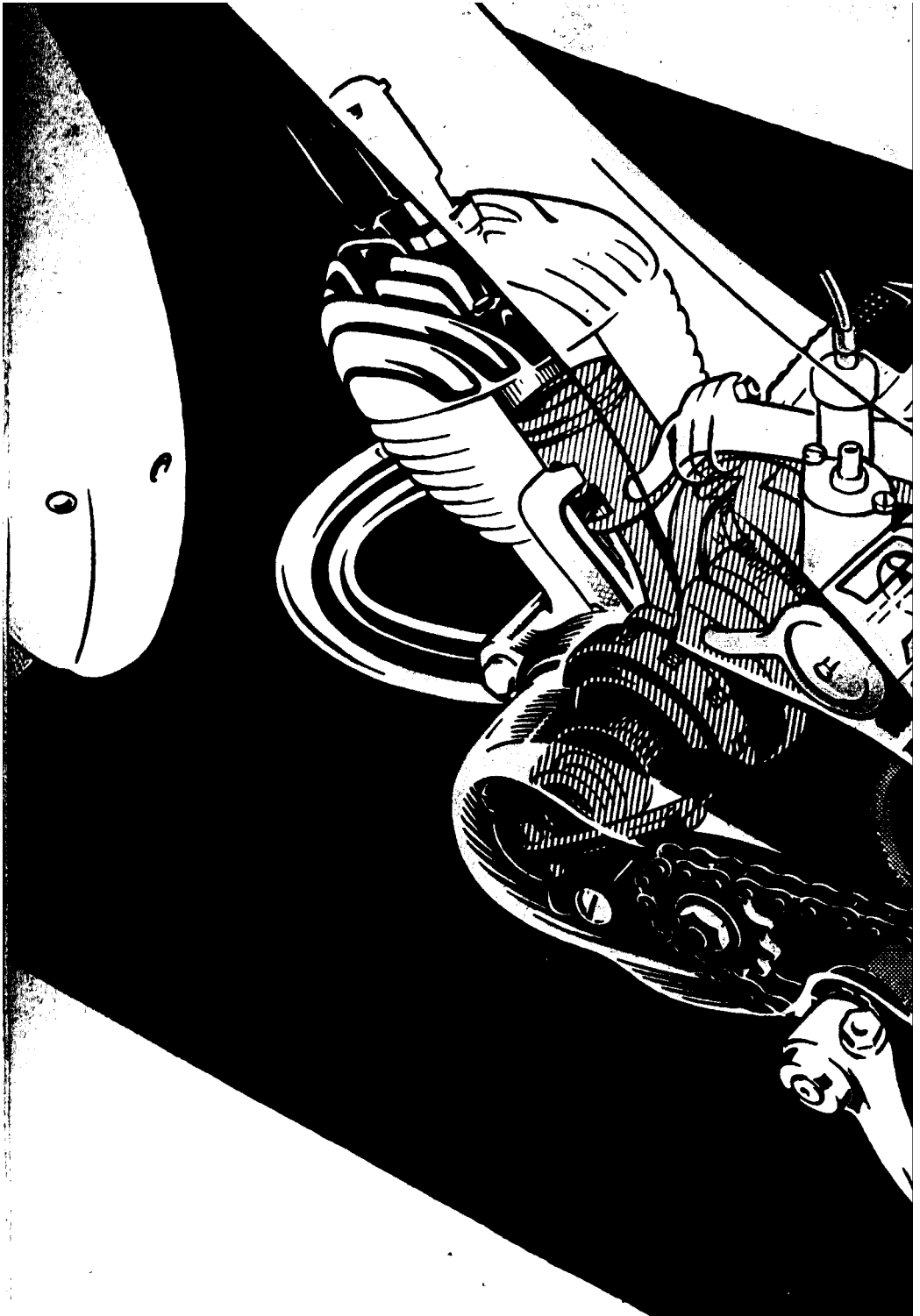

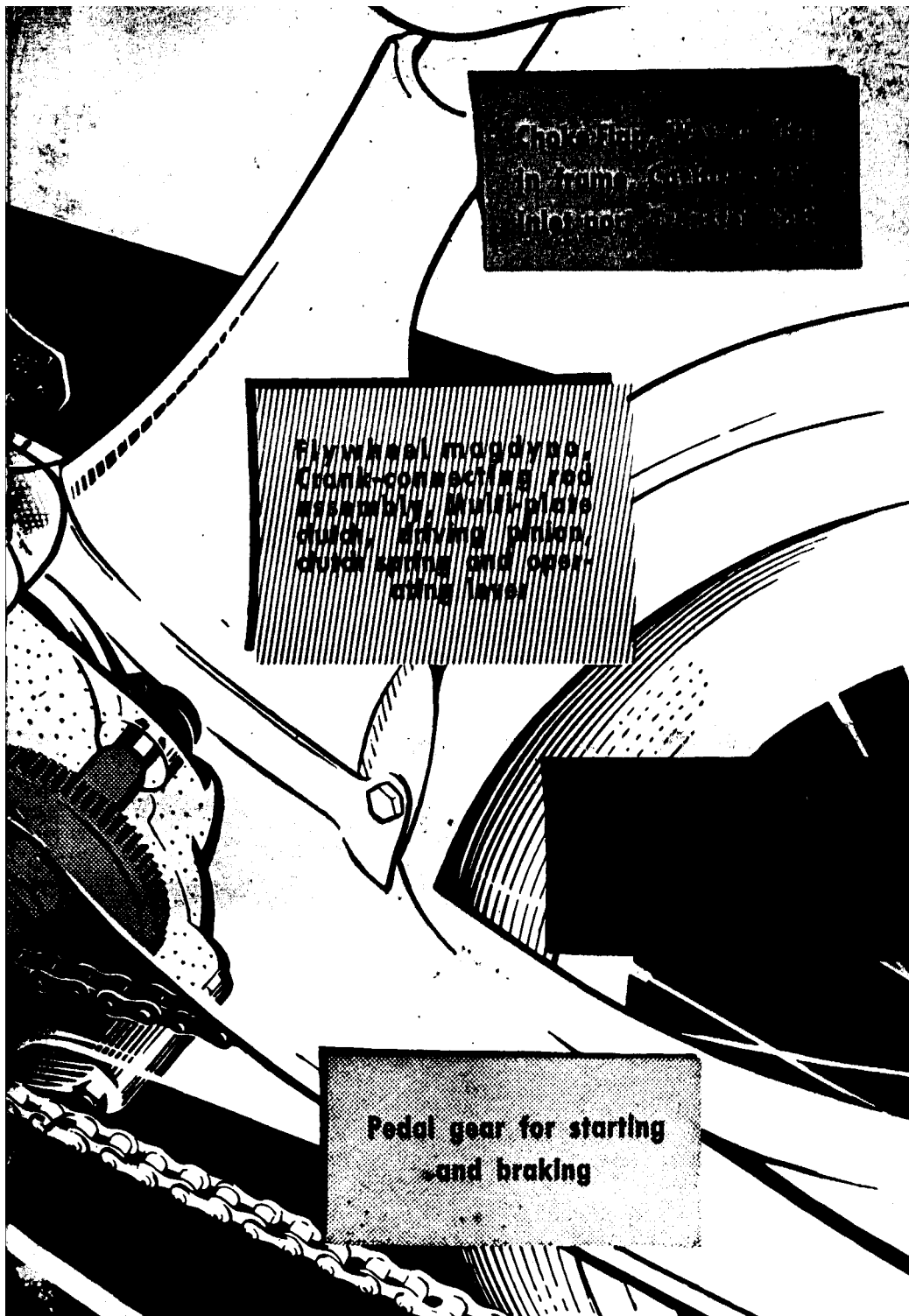

Chordless drive
In frame
Cable
In frame
In frame

Clyw wheel, magdyes,
Crank-connecting rod
assembly, Multiplate
clutch, driving pinion
clutch spring and over-
drive lever

Pedal gear for starting
and braking

MAINTENANCE

of the cycle parts

If the brakes fail to grip . . .

On the front wheel: loosen the lock nut, and adjust the brake cable by means of the adjuster on the hand-brake lever until the front wheel just spins freely, but the brake starts to operate as soon as the brake lever is pulled.

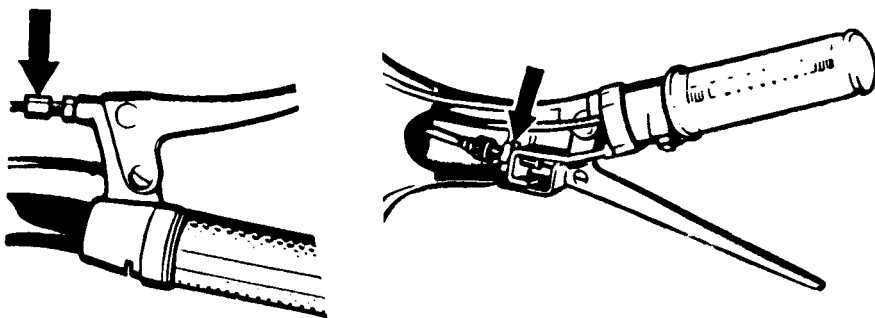

On the rear brake:

Quickly-N and S: Loosen the adjuster lock nut and set the adjuster so that the rear wheel rotates freely and so that the brake acts as soon as the lever is operated. **Then re-tighten the lock nut.**

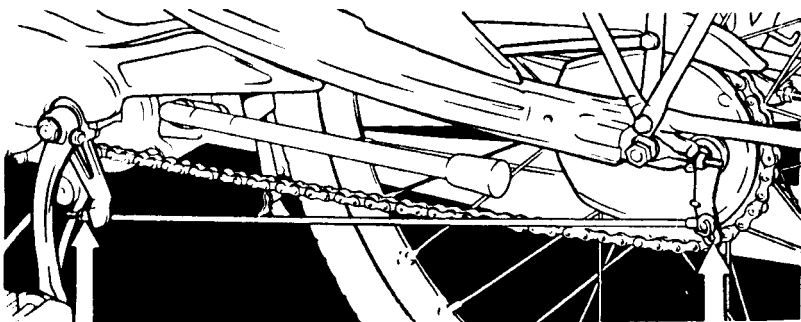

Quickly-L: Loosen the lock nut of the adjuster and adjust same for the rear wheel to spin freely and the brake to start gripping as soon as the brake lever is moved. **Tighten lock nut up again .**

The brake lever and the Bowden cable should lie roughly at right angles to each other. If the angle between them is very different from this value, slacken the hexagon nut and move the brake lever by one tooth or have the brake shoes relined.

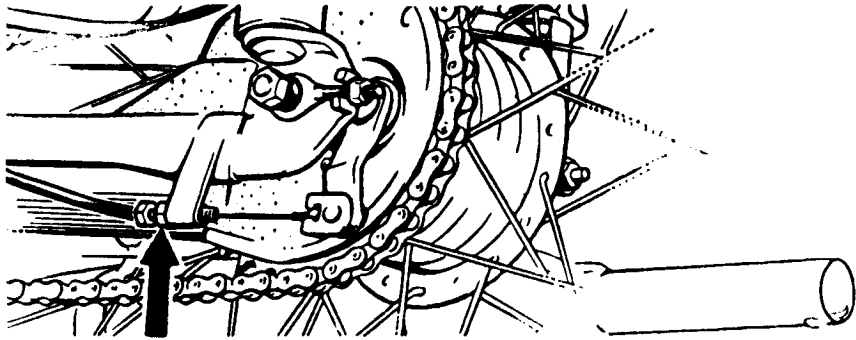

Chain Tension

Quickly-N and S: Change gear to neutral. The chain sag is correct if you can lift it about $19/32$ to $25/32$ in. To adjust this, first slacken off the spindle nuts, and then turn the two chain adjusters. To preserve the correct wheel alignment the hexagon nuts on these adjusters should both be turned **the same amount**. **Re-tighten the spindle nuts.** If necessary re-adjust the brake.

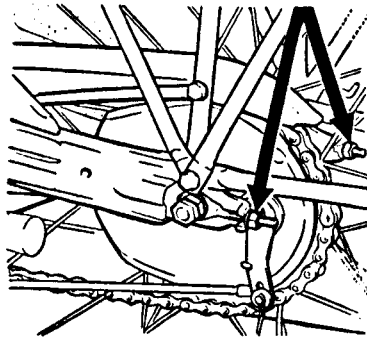

Quickly-L: Lower machine from its stand. Engage neutral. The chain sag of an unloaded machine is correct if you can lift it about $25/32$ in. **Check chain sag from time to time.**

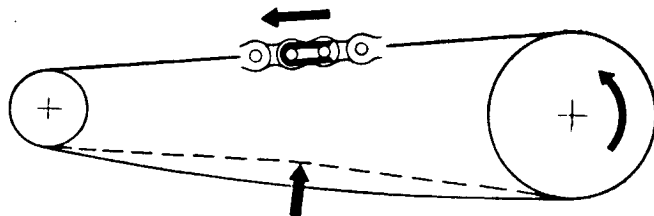

If adjustment is necessary first, slacken the knock-out spindle nuts and work on both chain adjusters, the hexagon nuts of which should be turned **the same amount**, to preserve the correct wheel alignment. **Re-tighten the spindle nuts.** If necessary re - adjust the brake.

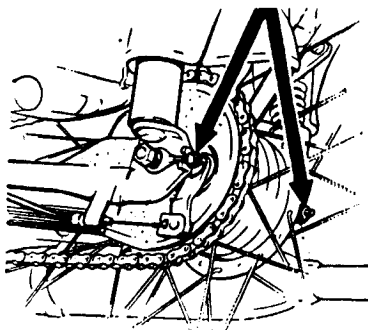

Note that if the chain is removed at any time the spring link should be on the outside, and its closed end should point in the direction of motion of the chain.

To remove the front wheel

Quickly-N and -S

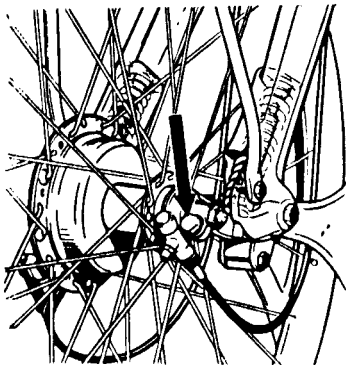

Quickly-L

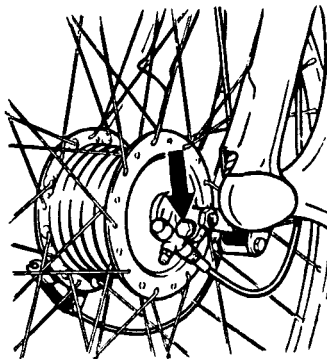

Slacken off the pinch bolts.

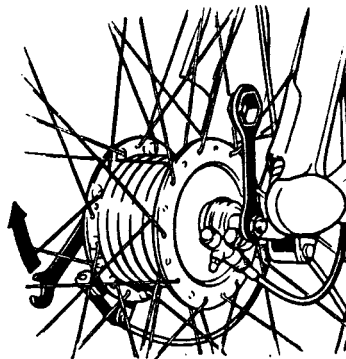
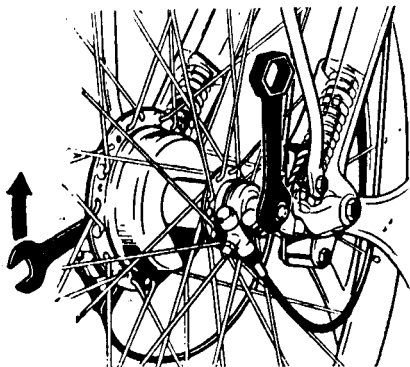
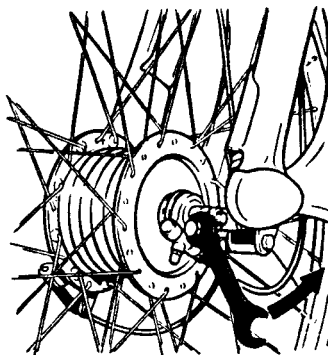
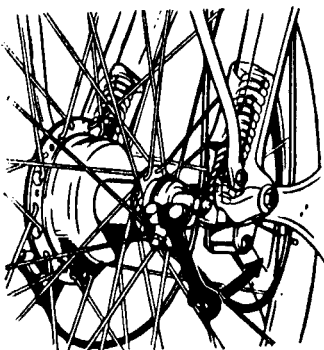

Remove the spindle nut.

Quickly-N and -S

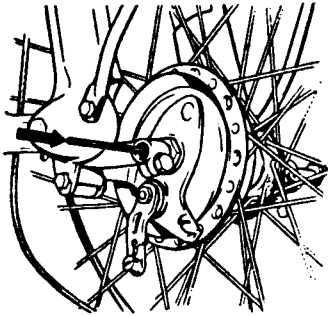

Quickly-L

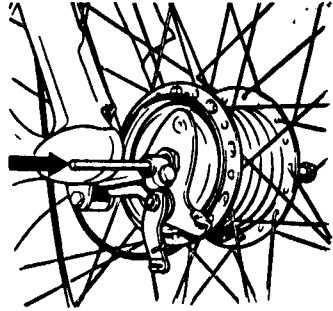

Disconnect the Bowden cable, drive out the spindle

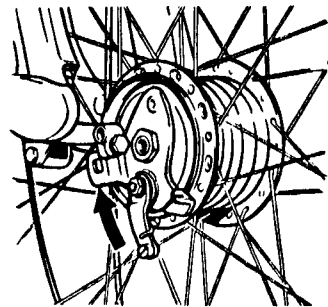
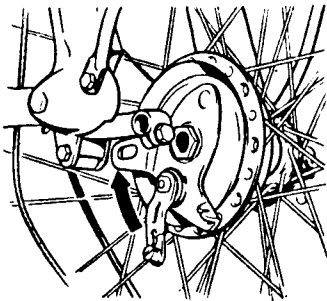
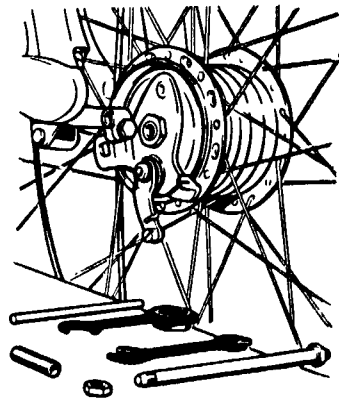
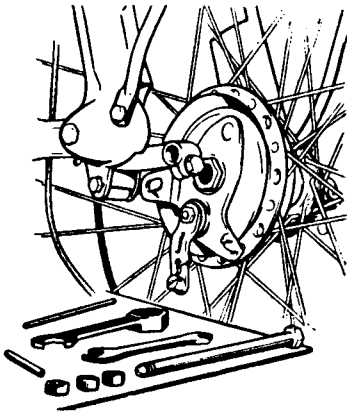

When replacing the wheel: Bring the brake plate to bear against the anchorage on the swinging arm and fit the spacer at the speedometer drive housing. The speedometer drive cable should sag slightly. (see left-hand page).

To remove rear wheel

Quickly-N and -S

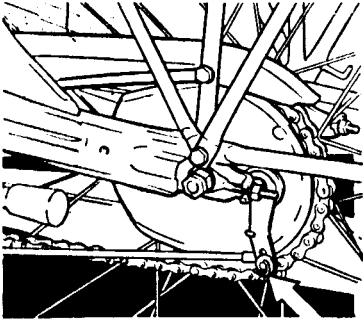

Remove the safety loop, and unhook the brake rod.

Quickly-L

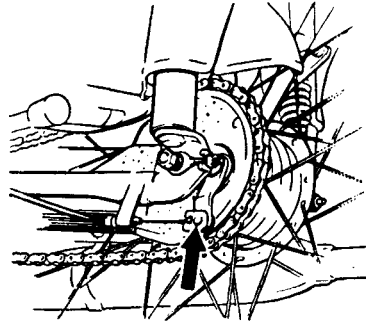

Remove the safety loop, and take off pin with washer.

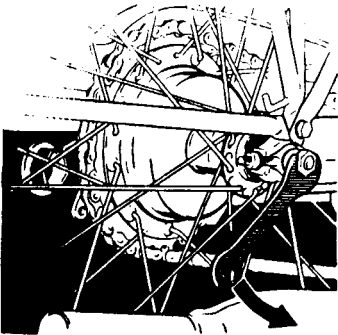

Slacken off the nuts of the chain adjusters; remove the spindle.

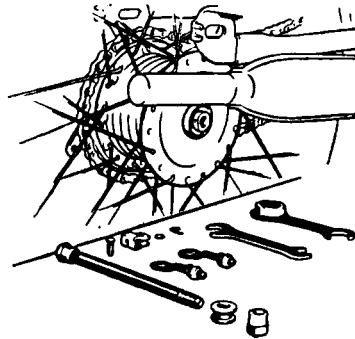
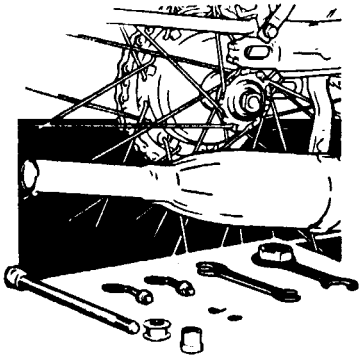
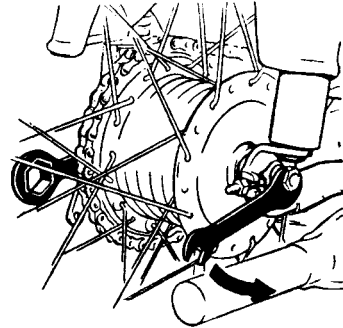

Quickly-N and -S

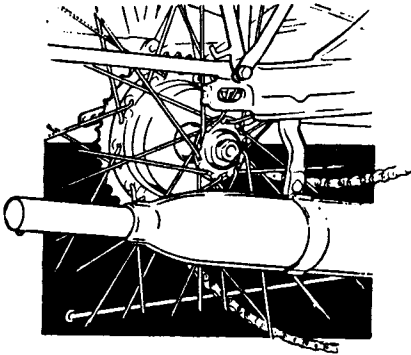

Quickly-L

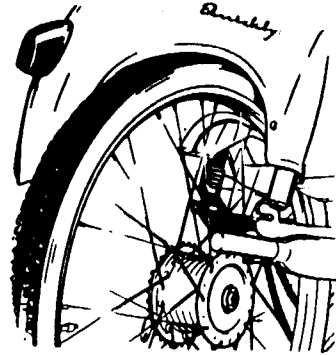

Slide the rear wheel forwards and take the chain off at the rear.

When replacing the wheel:

Quickly-N and S: Bring the brake plate to bear against the stop on the rear fork.

Quickly-L: Bring the brake plate to bear against the stop on the rear wheel swinging arm.

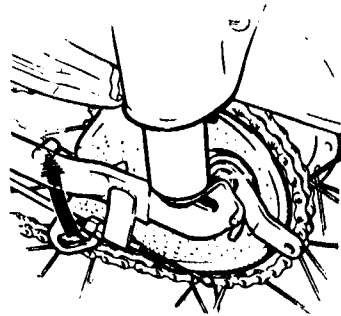
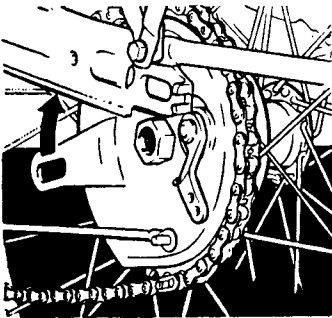

Adjust the chain tension see page 34

Fitting Tyres

Removing and replacing the wired-on low-pressure tyres on the well-base rims used on the QUICKLY presents no difficulties when you know how to do it. The point to remember, both when removing and when refitting the covers, is to have the tube completely deflated and to press the wall at one point right home into the well; the opposite part of the wall will then rise sufficiently for it to be lifted over the rim without any trouble. The use of force can be very dangerous, since this may easily result in the wires in the tyre breaking; if this happens the tyre will have to be scrapped.

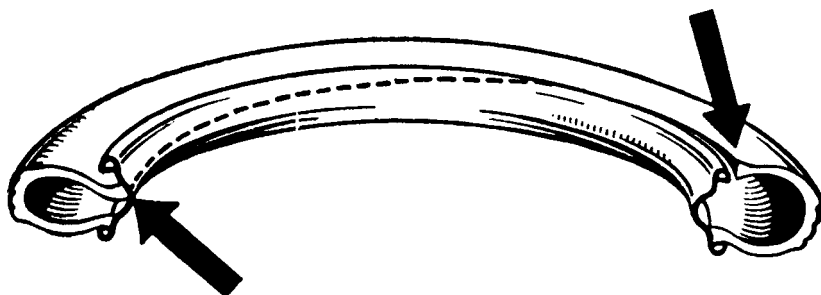

MAINTENANCE

of the engine

Adjusting the Dekompression Cable

There should be about 1 mm play in the cable. When the adjustment is completed, tighten the lock nut up again.

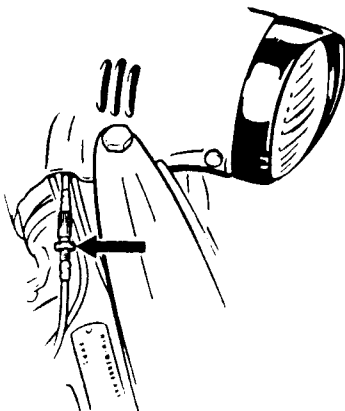

Clutch

If the clutch slips or fails to disengage properly, adjust the cable tension by means of the adjuster on the hand lever (left-hand handlebar), first slackening off the lock nut. The play in the clutch cable should be 2—3 mm. **Don't forget to tighten the lock nut up again.**

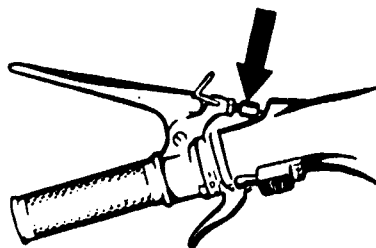
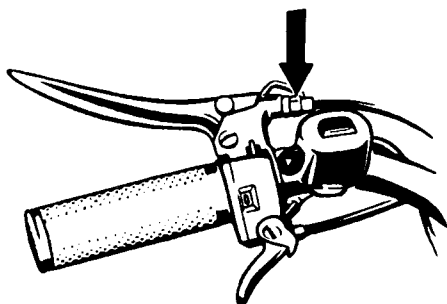

Gear Change Mechanism

To adjust the gear change mechanism, pull twistgrip towards 1st gear until the dogs are felt to be touching the gear wheel. Mark this position. Test the 2nd gear position in the same way. Once found out the middle position, adjust it to coincide with the neutral marking by means of the cable adjuster. It is, however, advisable to have this work done by a qualified NSU Service station.

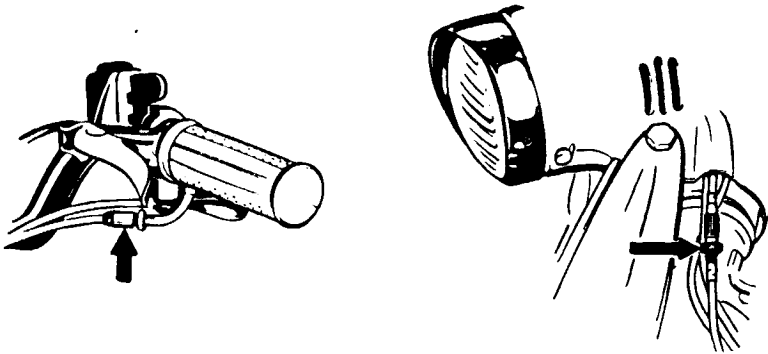

The carburettor

is a single slide Bing carburettor.

The manufacturer's carburettor settings will be found to give the best results as regards both fuel consumption and power output; it is, therefore, advisable not to alter these settings. The jet needle must not be bent, and it is advisable to flush out the tank and tap with petrol from time to time. If the jet becomes clogged clear it with a bristle; a piece of wire should never be used for this purpose.

When the throttle twist grip is fully closed, the throttle slide itself should remain slightly open, in order to ensure that the engine continues to tick over slowly without stalling. If necessary adjust the control cable, **after slackening the lock nut. When the adjustment is completed, tighten the lock nut up again.** If the throttle twist grip moves of its own accord, tighten up the friction bolt situated on the twist grip body by the cable guide.

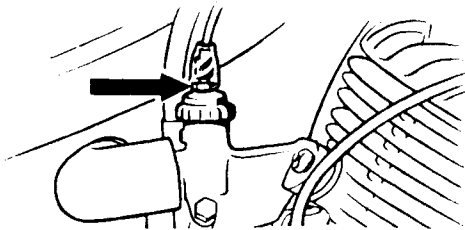

The appearance of the sparking plug electrodes gives some indication as to the correctness or otherwise of the carburettor adjustment. **Sparking plug sooted up:** a velvety matt black soot deposit. The carburettor setting is too rich, i.e. the needle is placed too high or the main jet is too large. Lack of air. If the fuel tap is closed while the engine is running, and the setting of the throttle twistgrip is left undisturbed, the engine will speed up before it stops.

Sparking plug overheated, i. e. insulator burnt white and spattered with molten metal; threaded portion of body and electrodes are tarnished (plug has formed a hot-point source of ignition). Carburettor setting too weak, or jet needle placed too low. Main jet too small or blocked. When accelerating the engine has a tendency to stall, low engine power, engine overheats. If the carburettor tickler is depressed the engine speeds up.

Sparking plug normal. Body of plug dark gray. A slight dry soot deposit on the sparking-plug body; carburettor settings correct.

In case of trouble seek the assistance of a motor-cycle repairer.

Electrical Equipment.

It is not advisable to carry out any work on the electrical installation other than checking the contacts, and replacing the bulbs and leads. If any other troubles are experienced it is better to go to a motor-cycle repairer,

To ensure ready starting and troublefree running, a **Bosch W 190 M 11 S sparking plug** with **0.7 mm electrode gap** or its equivalent must be fitted.

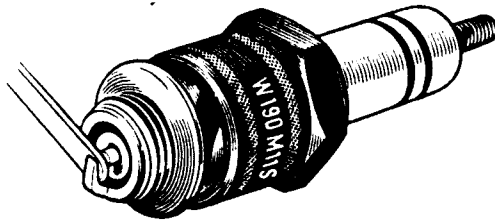

The Ignition Timing should be 2.1—2.5 mm before top dead centre when the contact breaker is just on the point of opening. A 0,03 to 0,05 mm feeler gauge held between the contact breaker points must just become free at this point so that it can be withdrawn. Do not use a piece of paper.

If the ignition timing is incorrect, the flywheel magdyno back plate must be turned in the required direction. This is achieved by slacking off the two bolts holding the back plate in position 1/2 to 1 turn, and turning the back plate by gently tapping a screwdriver held against it. After tightening up the two bolts again check the timing as described above.

Alter the marks on the back plate and the crankcase. If it is ever necessary to remove the back plate for reasons not connected with the ignition timing it is only necessary to line the back plate up with the marks when replacing it in order to be certain that the correct ignition timing is obtained.

since an expert will often by virtue of his experience be able to find and correct a fault which the layman will spend many hours searching for, and still not find.

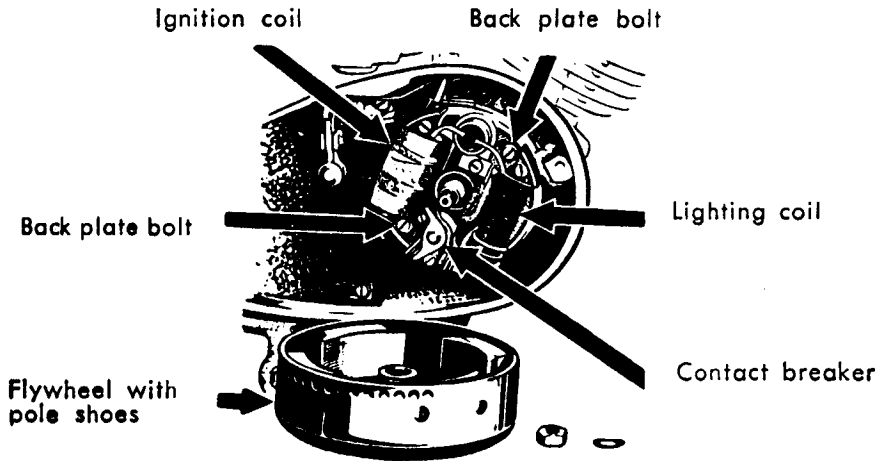

The contact-breaker gap should be 0.2 to 0.3 mm. If the fibre heel wears so that the rocker arm is not raised sufficiently, the contact holder must be adjusted by turning the eccentric until the required contact gap of 0.2 to 0.3 mm is obtained. Re-tighten the bolts securing the contact holder.

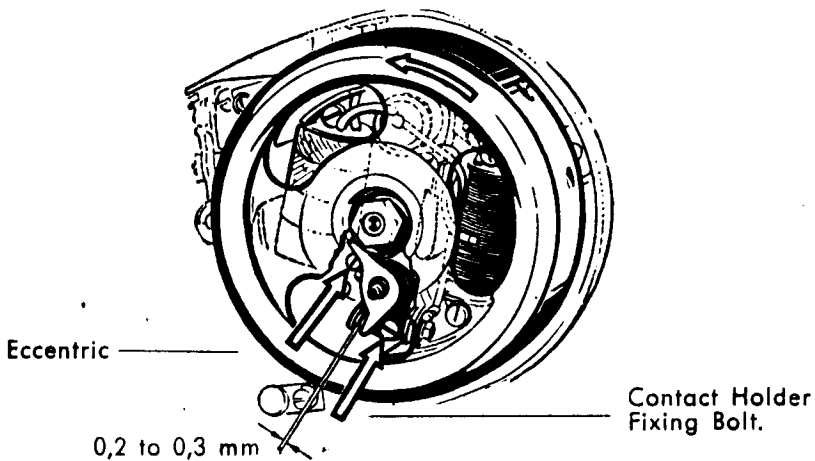

When replacing head lamp and rear lamp bulbs make certain that the new bulbs have the same voltage and wattage ratings as the original.

It is advisable to carry spare bulbs with you.

Head lamp adjustment.

The head lamp should be so adjusted that the centre of the beam meets the ground about 10 Meter in front of the QUICKLY.

Quickly-N and S: To adjust the headlamp loosen the hexagon screw.

Quickly-L: To adjust the head-lamp turn the slotted screw.
anticlockwise = lower
clockwise = higher

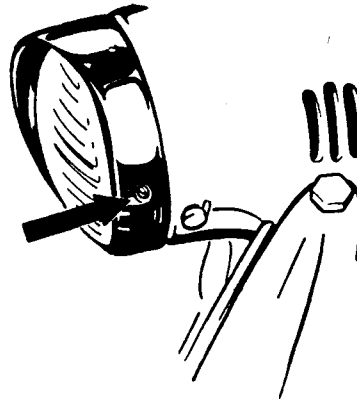
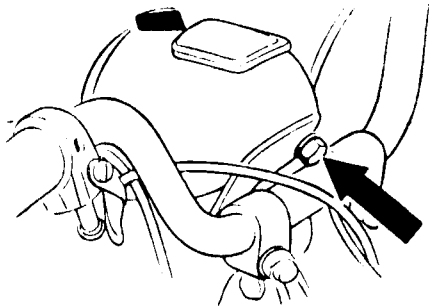

Engine Overhauls

If the engine power is found to drop in the course of time, it is usually necessary to decarbonise the cylinder and the exhaust system, in case of necessity reseal the compression release valve. The silencer can be dismantled, but don't make any alterations to it. It is advisable to have this work carried out by a motor-cycle repairer. In two-stroke engines the exhaust back-pressure affects the power output. Alterations to the silencer will result in a reduction in power and an increase in fuel consumption. There is also the point that the police take an extremely poor view of excessive exhaust noise!

When decarbonising the exhaust system, pull the baffle out of the silencer with a suitably bent end of wire.

To do this, remove the fixing screw from the exhaust pipe baffle.

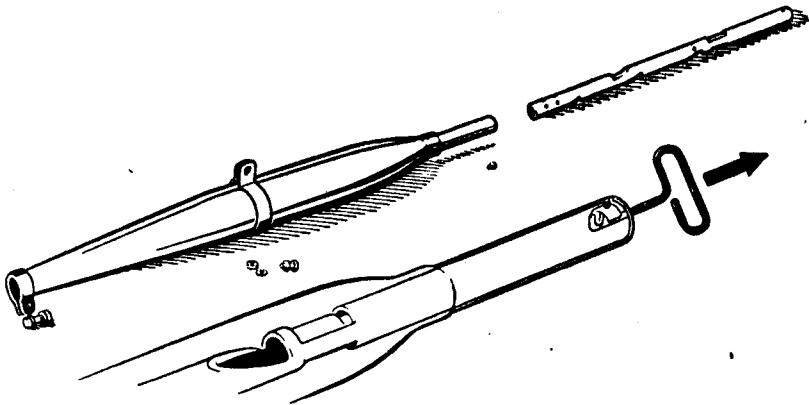

ROUTINE INSPECTION *

Every responsible rider will keep his machine in such a condition that traffic hazards are eliminated, and will consequently give special attention to a proper functioning of the brakes. We therefore recommend checking the brakes at the beginning of every ride, see p. 32/33.

Approximately every 300 miles

Tighten the cable-clamping bolts on the head lamp and the rear lamp.

Approximately every 600 miles

Check the chain tension and adjust as necessary. see p. 34/35.

Approximately every 600 miles

Clean the sparking plug. Check the electrode gap. see p. 45.

Approximately every 1 200 miles

Check the important screw joints respectively tighten as necessary **mainly the engine fastening on the frame**, the cylinder barrel the cylinder head, the spindle nuts, the silencer mountings.

Approximately every 1 200 miles

Decarbonise the cylinder head and the exhaust system, reseal the compression release valve. see p. 47.

Approximately every 1 200 miles

Check the play in the clutch and the gear-change mechanism. see p. 41/42. Check the play in the steering-head bearings — Adjust the steering-head bearings slightly running but without perceptible play.

(With the machine raised so that the front wheel is off the ground, and with the steering damper slackened right off, the front forks should turn of their own accord until they hit the stop when they are displaced slightly from the central position)

Approximately every 2 400 miles

Check the contact breaker gap. Check the electrical leads and connections, tighten the cable-clamping bolts. see p. 44.

* It is advisable to have these works carried out in the repair shop of an NSU-Agency.

Lubrication Chart

<u>Location</u>	<u>Lubricant</u>
Engine	Proprietary SAE 50 two-stroke oil mixed with fuel in proportion 1 Imp. Gall Fuel : 1/3 Pint Oil
Gearbox and linkages, Pedal mechanism	In summer a proprietary SAE 30 engine oil In winter a proprietary SAE 20 engine oil. or in the case of the gearbox a proprietary SAE 80 gear oil can be used.
Swinging link bearings on front forks Front and rear wheel bearings Bearings of rear wheel swinging arm Quickly-L Bowden cable for rear brake Quickly-L Speedometer drive Interior of throttle and gear change twist-grips Steering Head Bearings	High pressure grease
Driving chain	Chain grease
Lubricating pad on contact breaker	Bearing grease (drip point 150-160° C)

Routine Lubrication *

	Page No. in the Instructio Book	
L	First and second oil changes	16
u	Swinging link bearings on front fork, Bearings of rear wheel swinging arm, Bowden cable of rear brake	23 / 24
b	Check oil level in gearbox and top up as necessary	24
r	Driving chain	25
i	Bearing of brake rod, Bowden cable of rear brake	25
c	Air filter, Carburettor and Strainer	26 / 42
a	Routine gearbox oil changes	27
t	Bowden cables	27
i	Levers and joints	28
o	Speedometer Drive	28
n	Lubricating pad	28
	Pedal crank bearings	29
	Interior of throttle and gear change twist grips	29
	Front and rear wheel bearings	29
<hr/>		
	Check the tyre pressure and brakes before each journey	16 / 48
	Check the chain tension	34 / 48
I	Check the play in the clutch and the gear-change mechanism	41 / 42 / 48
n	Check the contact-breaker gap	44 / 48
s	Sparking plug	45 / 48
p	Decarbonise Cylinder, Cylinderhead and exhaust system, and reseal the compression release valve	47 / 48
e	Tighten the cable-clamping bolts on the head lamp and the rear lamp	48
c	Check all the main threaded connections on the engine and frame, and tighten as necessary	48
t	Check play in steering-head bearing	48

* It is advisable to have these works carried out in the repair shop of an NSU-Agency

Flat rate times for repair tasks

The Flat Rate Repair Times have been calculated for vehicles with standard equipment. The Time required for any cleaning is **not** included.

Engine	Time for task (hours)	Additional work required	Total time (hours)
M 01 Remove engine from frame and replace	1½	—	1½
M 02 Strip and assemble engine . .	3¾	M 01	5¼
M 04 Remove and fit cylinder head	¼	—	¼
M 10 Remove and fit cylinder and piston	¼	M 04	½
M 11 Decarbonise cylinder head, piston, and exhaust system . .	¼	M 04	½
M 15 Remove and fit clutch. Adjust and replace any parts necessary	1¼	M 16	1½
M 16 Remove and fit chainguard .	¼	—	¼
M 21 Remove and fit chain sprocket (engine)	¼	M 16	½
M 22 Remove and fit circlip on chain sprocket	¼	M 16, M 21	¾
M 25 Remove and fit rear chain . .	¼	—	¼
M 30 Remove and fit crankshaft and main bearings	¼	M 01, M 02	5½
M 31 Remove and fit crankcase . .	¼	M 01, M 02	5½
M 32 Change crankcase gasket . . .	3	M 01	4½
M 35 Remove and fit gearbox and gearchange mechanism, replace parts as necessary	¼	M 01, M 02	5½
M 36 Remove and fit gearbox shaft bearings and bushes	¼	M 01, M 02	5½

	Time for task (hours)	Additional work required	Total time (hours)
M 50 Remove and fit magneto cover plate	¼	—	¼
Ignition System and Dynamo			
Z 01 Adjust ignition timing	¼	M 50	½
Z 02 Remove and fit dynamo; adjust	¼	M 50	½
Z 03 Remove and fit contact-breaker points; adjust	¼	M 50, Z 02	¾
Z 04 Remove and fit condenser; check	¼	M 50, Z 02	¾
Z 05 Remove and fit ignition coil; check	¼	M 50, Z 02	¾
Z 06 Remove and fit ignition lead	¼	M 50, Z 02	¾
Carburettor			
V 01 Remove and fit air filter; clean	¼	—	¼
V 02 Remove and fit carburettor; clean, adjust, replace, parts as necessary	¼	—	¼
Wheels, Brakes, and Forks			
F 01 Remove and fit front wheel. N, S, L	¼	—	¼
F 02 Remove and fit rear wheel N, S, L	¼	—	¼
F 03 Remove and fit ball-bearing cup or seal in hub N	½	F 01 or F 02	¾
Remove and fit ball-bearing cup or seal in hub . . . S, L	½	F 01, F 04 or F 02, F 05	1
F 04 Remove and fit front-brake back plate N, S, L	¼	F 01	½

		Time for task (hours)	Additional work required	Total time (hours)
F 05	Remove and fit rear-brake back plate	N, S, L ¼	F 02	½
F 06	Remove and fit rear sprocket	S, L ¼	F 02, F 05	¾
F 07	Remove and fit rear hub cover	S, L ¼	F 02, F 05	¾
F 08	Renew brake linings (each brake)	N, S, L ¾	F 01, F 04 or F 02/F 05	1¼
F 20	Remove and fit forks	N, S 1¼	F 01	1½
	Remove and fit forks	L ½	F 26, F 42, F 84 or E 08, E 13	1¾
F 21	Remove and fit steering-head cones and cups and ball bearings	N ¼	F 20, F 01	1¼
	Remove and fit steering-head cones and cups and ball bearings	S, L ¼	F 20	2
F 24	Remove and fit pivoted links (left-hand and right-hand)	N, S, L ¾	F 01	1
F 25	Replace bushes in pivoted links	N, S, L ¾	F 01/F 24	1¾
F 26	Remove and fit front mudguard	N, S, L ¼	F 01	½
Controls and Bowden Cables				
F 40	Remove and fit handlebars (with fittings)	N, S ¾	—	¾
	Remove and fit handlebars (with fittings)	L ¼	F 42, F 84 or E 08, E 13, E 50, F 51, F 52, F 53, F 54	1½

		Time for task (hours)	Additional work required	Total time (hours)
F 41	Remove and fit handlebar bend	N, S ¼	—	¼
	Remove and fit handlebar bend	L —	F 40, F 44 F 44a, F 45, F 46	2½
F 42	Remove and fit speedometer	L ¼	E 13	½
F 43	Remove and fit flexible drive, speedometer	L —	F 42	½
F 44	Remove and fit brake lever or clutch lever	N, S, L ¼	—	¼
F 44a	Remove and fit control lever, clutch	L ¼	—	¼
F 45	Remove and fit throttle twistgrip	N, S, L ¼	—	¼
F 46	Remove and fit gear change twistgrip	N, S ¼	—	¼
	Remove and fit gear change twistgrip	L ¼	F 42 s. F 50 and F 54	1
F 47	Remove and fit twistgrip sleeve	N, S, L ¼	—	¼
F 48	Remove and fit slider	N, S, L ¼	s. F 53	¼
F 50	Remove and fit clutch cable	N, S ¼	M 16	½
	Remove and fit clutch cable	L ½	E 13	¾
F 51	Remove and fit brake cable	N, S, L ¼	—	¼

		Time for task (hours)	Additional work required	Total time (hours)
F 52	Remove and fit decompression cable N, S	¼	—	¼
	Remove and fit decompression cable L	¼	E 13	½
F 53	Remove and fit throttle cable N, S	¼	—	¼
	Remove and fit throttle cable L	¼	F 45	½
F 54	Remove and fit gearchange cable N, S	¼	M 50	½
	Remove and fit gearchange cable L	½	s. F 46	1
F 56	Remove and fit control cable, rear brake L	¼	—	¼
Frame				
F 60	Remove and fit frame . . . N, S	—	M 01, F 02, F 20, F 62, F 72, F 75, F 80	4½
	Remove and fit frame . . . L	¼	F 20, F 63, F 70, F 80, M 01	5¾
F 62	Remove and fit rear mudguard N, S	½	F 02	¾
	Remove and fit rear frame member L	½	F 02, F 72, E 09	1¼
F 63	Remove and fit rear suspension swinging arm L	¾	F 62	2
F 65	Remove and fit rear suspension L	¼	F 62, F 63	1¾

		Time for task (hours)	Additional work required	Total time (hours)
F 70	Remove and fit exhaust system	N, S, L ¼	—	¼
F 72	Remove and fit pivoted saddle	N, S, L ¼	—	¼
F 73	Remove and fit prop stand	S, L ¼	—	¼
F 74	Remove and fit centre stand	N, S, L ¼	—	¼
F 75	Remove and fit luggage carrier	N, S ¼	—	¼
	Remove and fit parcel-carrier strips	L ¼	F 02	½
F 80	Remove and fit fuel tank	N, S, L ¼	—	¼
F 82	Remove and fit fuel tap	N, S, L ¼	—	¼
F 84	Remove and fit bell	L ¼	E 13	½
F 85	Remove and fit pedals	N, S, L ¼	—	¼
Electrical Installation				
E 02	Remove and fit rear lamp lead	N, S, L ¾	E 13	1
E 04	Remove and fit lighting leads	N, S, L ¾	E 13	1
E 05	Remove and fit cables, dipped beam	L (Exp.) —	E 13, E 10	½
E 08	Remove and fit rattle	L (Exp.) ¼	E 13	½
E 09	Remove and fit rear lamp	N, S, L ¼	—	¼

		Time for task (hours)	Additional work required	Total time (hours)
E 10	Remove and fit dipswitch L (Exp.)	¼	—	¼
E 12	Remove and fit headlamp glass or reflector N, S	¼	—	¼
	Remove and fit headlamp glass and reflector L	¼	E 13	½
E 13	Remove and fit headlamp N, S	½	—	½
	Remove and fit headlamp unit L	¼	—	¼
Care and Maintenance				
W 01	Grease vehicle N, S	¼	—	¼
	Grease vehicle L	½	—	½

Fault Tracing*

The engine does not start. No petrol overflows when the carburettor tickler is depressed.

Fuel tap closed / Fuel tank empty / Fuel tap or pipe blocked / Float not fitting properly on float needle.

The engine does not start. Petrol overflows when the carburettor tickler is depressed.

Jet blocked / Water in the carburettor / Twist-grip wrongly handled / Choke flap wrongly adjusted / High-tension lead disconnected, loose or faulty / Excessive carburettor flooding, resulting in a drowned plug / Sparking plug oiled-up, sooted-up, or electrodes bridged by a foreign body / Wrong sparking plug / Wrong electrode gap / Faulty sparking plug (Insulation broken down) / Contact breaker dirty or sticking / Wrong gap at contact breaker points / Contact breaker points oiled-up, dirty, or in need of replacement.

The engine stops or fires irregularly.

Fuel supply exhausted / Water in the carburettor / Air supply incorrect (loose carburettor) / Jet needle disconnected / Float not fitting properly on float needle / Leaky float / Too much oil in fuel (Proper petrol mixture should be 1 Imp. Gall. Fuel : $\frac{1}{3}$ Pint Oil / High-tension lead loose or defective / Faulty sparking plug, or wrong type of plug / Contact breaker points oiled-up; dirty, or in need of replacement.

Engine power drops rapidly.

Heavy carbon deposits in exhaust port / Silencer blocked by carbon deposits / Piston ring sticking, worn out, or broken / Choke flap wrongly adjusted / Dirty air filter / Wrong air-fuel mixture strength / Jet needle disconnected / Carburettor floods: Leaky float, float needle out of position, float needle or tickler sticking / Wrong petrol mixture / Wrong sparking plug / Ignition timing incorrect / Clutch slipping / Brakes binding / Mechanical (friction) losses in the transmission or wheels.

Engine stops.

Fuel supply exhausted / High-tension lead disconnected / Faulty sparking plug or metal beads deposited on electrodes / Contact breaker sticking.

Lamps fall to light.

Bulbs worked loose or defective. / (It is advisable to carry spare bulbs) / Bad earth connection (in head lamp or rear lamp) / Lead disconnected or loose (oxidised) / Short circuit, insulation frayed through.

* If in doubt refer to a motor-cycle repairer.

Wiring diagram

Quickly L

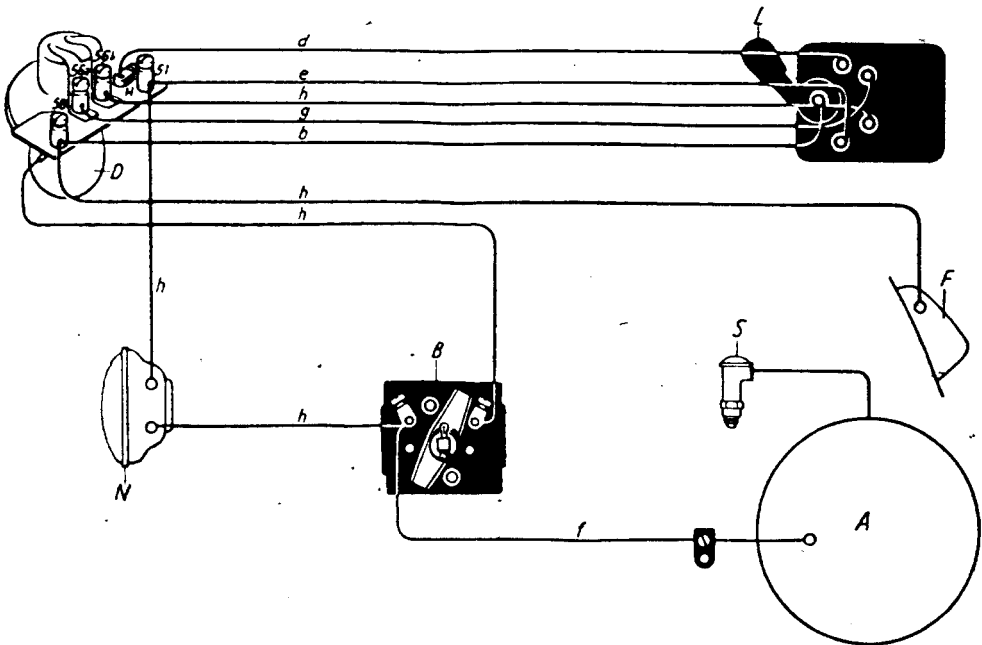

- A Flywheel Dynamo
- B Starting, Ignition and Lighting Switch
- D Headlamp Bulb (double-filament)
- F Tail Light Bulb
- L Dipper Switch
- N Horn
- S Sparking Plug

- b red
- d yellow
- e white
- f blue
- g green
- h grey

Wiring diagram

Quickly N and S

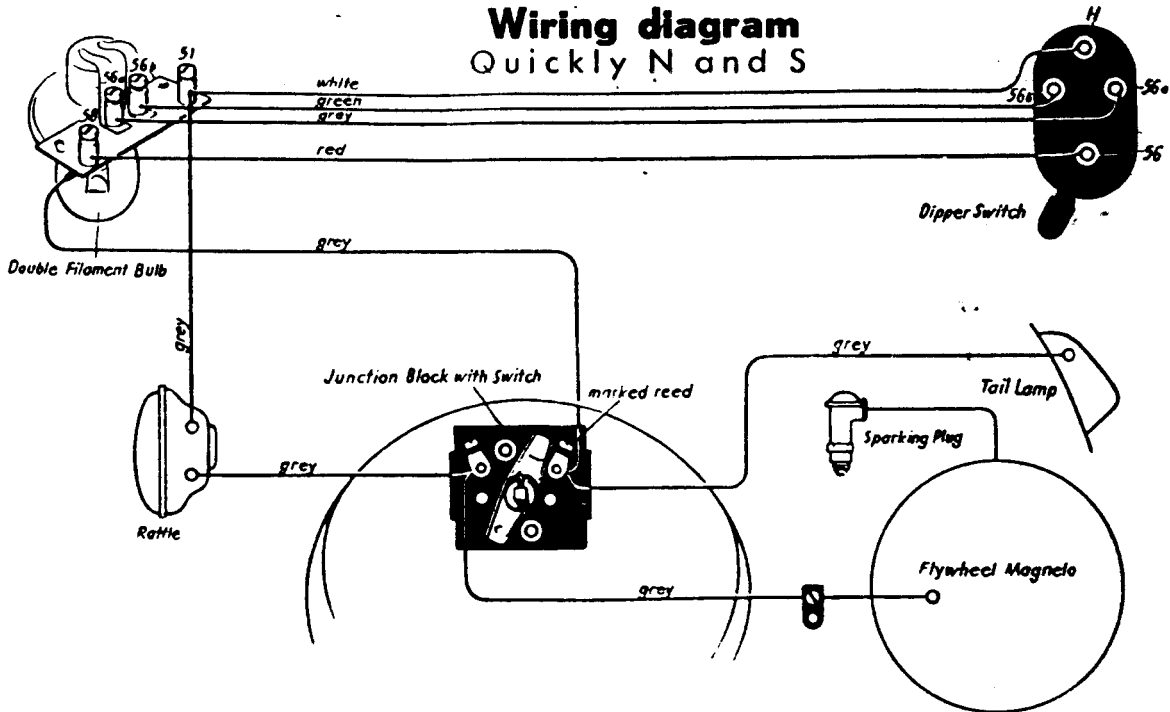

PARTS & ACCESSORIES

Click on links below

[*Motorcycle Parts & Accessories*](#)

[*Dirt Bike Parts & Accessories*](#)

[*Cruiser Motorcycle Parts & Accessories*](#)

[*Japanese Motorcycle OEM Parts & Online Schematics*](#)

[*Save Up to 45% on Motorcycle Tires*](#)

[*JC Whitney Motorcycle Parts & Accessories*](#)

[*Motorcycle Gear Closeout Sale*](#)

[*Free Shipping On All Mini Bikes*](#)

[*Cycle Gear Free Shipping*](#)

[*Mega Motor Madness*](#)

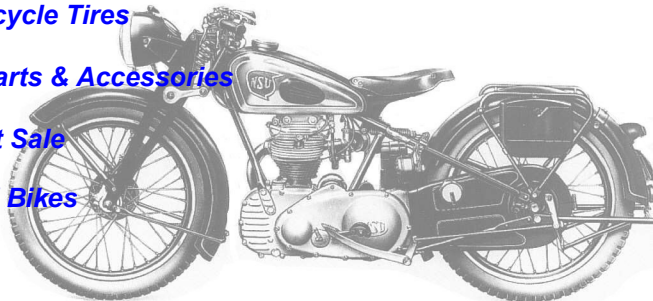

[*www.ClassicCycles.org*](http://www.ClassicCycles.org)